

Glaseptik-Dosen

Glass-look jars | Pots paroi épaisse aspect verre

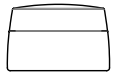



ALLEGRA-LINE

(5) | 15 ml

1

50 ml

2

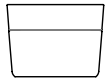

CITY-LINE

(5) | 15 ml

3

(15/30) | 50 ml

4



DIAMOND-LINE

(5) | 15 ml

5

(15/30) | 50 ml

6



DROP-LINE

5 | 30 | 50 ml

7



ELEGANCE-LIGHT-LINE

(5) | 15 | (30) | 50 | 200 ml

8



ELEGANCE-LINE

(5) | 15 | 30 ml

9

(15/30) | 50 | 200 ml

10



TOP-LIGHT-LINE

(5) | 15 | (30) | 50 ml

11



TOP-LINE

(5) | 15 ml

12

(15) | 30 | 50 ml

13

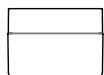

TREND-LINE

5 | (15) | 30 | 50 ml

14

100 | 200 ml

15

GLASOPTIK-DOSEN | Glass-look jars | Pots paroi épaisse aspect verre

DIMENSIONEN | Dimensions | Dimensions

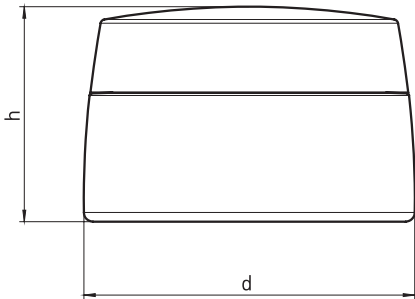

d = MAX. DURCHMESSER | Max. diameter | Diamètre max.
h = GESAMTHÖHE | Overall height | Hauteur totale

DECKELVARIANTEN | Optional lids | Variantes de couvercle

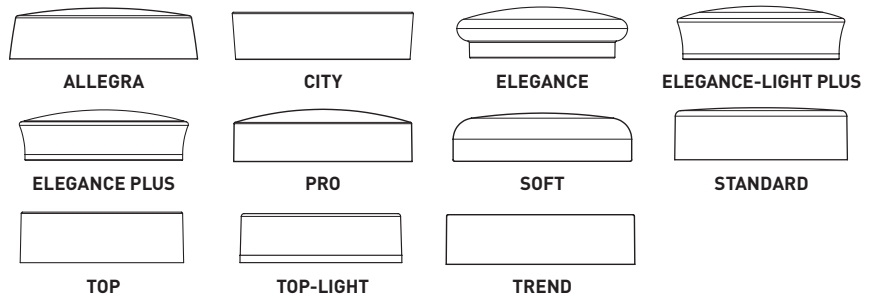

MATERIAL | Material | Matière

UNTERTEIL | Jar | Pot: **SAN**
EINSATZ | Insert | Insert: **PP**
SCHRAUBDECKEL | Lid | Couvercle à vis: **PP, SAN, PP/PP, SAN/PP**

INDIVIDUELLE DEKORATION

Einfärbung, Druck, Prägung, Lackierung und Metallisierung.

CUSTOMIZATION

Coloured material, printing, hot foil stamping, lacquering and metallization.

DÉCORATION PERSONNALISÉE

Coloration dans la masse, sérigraphie, marquage à chaud, laquage et métallisation.

TECHNISCHE DATEN | Technical details | Spécifications techniques

NENN-VOLUMEN Volume Volume ml	DOSENUNTERTEIL Jar Pot				SCHRAUBDECKEL Lid Couvercle à vis							DIMENSIONEN Dimensions Dimensions (mm)	
	NR. No. N°	MATERIAL Material Matière	OBERFLÄCHE Surface Aspect		SERIE Series Série	MATERIAL Material Matière	OBERFLÄCHE Surface Aspect		EINLAGE Liner Joint	AUFPLAGE Disc Opercule	DICHTLIPPE Sealing rim Lèvre d'étanchéité	d	h
			GLATT smooth lisse	MATT matt mat			GLATT smooth lisse	MATT matt mat					
3911	SAN	•			ALLEGRA	SAN/PP	•		•			46	40
					CITY	SAN/PP	•		•			46	39
					ELEGANCE	PP	•	•	•			46	39
					ELEGANCE-LIGHT PLUS	PP		•	•			46	40
					ELEGANCE PLUS	PP		•	•			46	39
					STANDARD	SAN	•		•			46	38
					STANDARD-R	PP/PP	•		•			46	40
					TOP	PP/PP		•	•			46	40
					TOP	SAN/PP	•		•			46	40
					TOP-LIGHT	PP		•	•			46	38
15	MIT EINSATZ with insert avec insert				[AUCH REDUZIER-EINSATZ 5 ml VORHANDEN we also stock reduction inserts in 5 ml réducteur également disponible en 5 ml]								
	3912	SAN/PP	•		ALLEGRA	SAN/PP	•		•			46	40
					CITY	SAN/PP	•		•			46	39
					ELEGANCE	PP	•	•	•			46	39
					ELEGANCE-LIGHT PLUS	PP		•	•			46	40
					ELEGANCE PLUS	PP		•	•			46	39
					STANDARD	SAN	•		•			46	38
					STANDARD-R	PP/PP	•		•			46	40
					TOP	PP/PP		•	•			46	40
					TOP	SAN/PP	•		•			46	40
TOP-LIGHT					PP		•	•			46	38	

GLASOPTIK-DOSEN | Glass-look jars | Pots paroi épaisse aspect verre

TECHNISCHE DATEN | Technical details | Spécifications techniques

NENNVOLUMEN Volume Volume ml	DOSENUNTERTEIL Jar Pot				SCHRAUBDECKEL Lid Couverture à vis				EINLAGE Liner Joint	AUFLAGE Disc Opercule	DICHTLIPPE Sealing rim Lèvre d'étanchéité	DIMENSIONEN Dimensions Dimensions (mm)		
	NR. No. N°	MATERIAL Material Matière	OBERFLÄCHE Surface Aspect		SERIE Series Série	MATERIAL Material Matière	OBERFLÄCHE Surface Aspect					d	h	
			GLATT smooth lisse	MATT matt mat			GLATT smooth lisse	MATT matt mat						
50	3909	SAN	•		ALLEGRA	SAN/PP	•		•			72	48	
					PRO	PP	•		•			72	48	
					SOFT	SAN	•		•			72	48	
					SOFT	PP	•	•	•			72	46	
					TREND	SAN/PP	•	•	•			72	47	
	MIT EINSATZ with insert avec insert													
	3910	SAN/PP	•		ALLEGRA	SAN/PP	•		•				72	48
					PRO	PP	•		•			72	48	
					SOFT	SAN	•		•			72	48	
					SOFT	PP	•	•	•			72	46	
TREND					SAN/PP	•	•	•			72	47		

GLASOPTIK-DOSEN | Glass-look jars | Pots paroi épaisse aspect verre

DIMENSIONEN | Dimensions | Dimensions

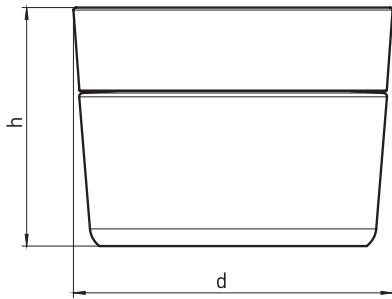

d = MAX. DURCHMESSER | Max. diameter | Diamètre max.
h = GESAMTHÖHE | Overall height | Hauteur totale

DECKELVARIANTEN | Optional lids | Variantes de couvercle

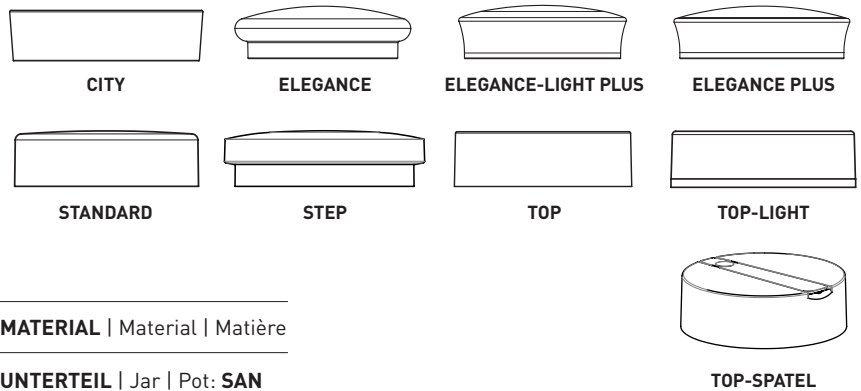

MATERIAL | Material | Matière

UNTERTEIL | Jar | Pot: **SAN**
EINSATZ | Insert | Insert: **PP**
SCHRAUBDECKEL | Lid | Couvercle à vis: **PP, SAN, PP/PP, PS/PP, SAN/PP**

INDIVIDUELLE DEKORATION

Einfärbung, Druck, Prägung, Lackierung und Metallisierung.

CUSTOMIZATION

Coloured material, printing, hot foil stamping, lacquering and metallization.

DÉCORATION PERSONNALISÉE

Coloration dans la masse, sérigraphie, marquage à chaud, laquage et métallisation.

TECHNISCHE DATEN | Technical details | Spécifications techniques

NENN VOLUMEN Volume Volume ml	DOSENUNTERTEIL Jar Pot				SCHRAUBDECKEL Lid Couvercle à vis				EINLAGE Liner Joint	AUFPLAGE Disc Opercule	DICHTLIPPE Sealing rim Lèvre d'étanchéité	DIMENSIONEN Dimensions Dimensions (mm)	
	NR. No. N°	MATERIAL Material Matière	OBERFLÄCHE Surface Aspect		SERIE Series Série	MATERIAL Material Matière	OBERFLÄCHE Surface Aspect					d	h
			GLATT smooth lisse	MATT matt mat			GLATT smooth lisse	MATT matt mat					
3800	SAN	•			ALLEGRA	SAN/PP	•		•			45	39
					CITY	SAN/PP	•		•			46	38
					ELEGANCE	PP	•	•	•			45	38
					ELEGANCE-LIGHT PLUS	PP		•	•			45	38
					ELEGANCE PLUS	PP		•	•			45	38
					STANDARD	SAN	•		•			45	37
					STANDARD-R	PP/PP	•		•			45	40
					TOP	PP/PP		•	•			45	39
					TOP	SAN/PP	•		•			45	39
					TOP-LIGHT	PP		•	•			45	37
15	MIT EINSATZ with insert avec insert				[AUCH REDUZIER-EINSATZ 5 ml VORHANDEN we also stock reduction inserts in 5 ml réducteur également disponible en 5 ml]								
	3801	SAN/PP	•		ALLEGRA	SAN/PP	•		•			45	40
					CITY	SAN/PP	•		•			46	39
					ELEGANCE	PP	•	•	•			45	39
					ELEGANCE-LIGHT PLUS	PP		•	•			45	39
					ELEGANCE PLUS	PP		•	•			45	39
					STANDARD	SAN	•		•			45	38
					STANDARD-R	PP/PP	•		•			45	41
					TOP	PP/PP		•	•			45	40
					TOP	SAN/PP	•		•			45	40
TOP-LIGHT					PP		•	•			45	38	

GLASOPTIK-DOSEN | Glass-look jars | Pots paroi épaisse aspect verre

TECHNISCHE DATEN | Technical details | Spécifications techniques

NENNVOLUMEN Volume Volume ml	DOSENUNTERTEIL Jar Pot				SCHRAUBDECKEL Lid Couverture à vis				EINLAGE Liner Joint	AUFLAGE Disc Opercule	DICHTLIPPE Sealing rim Lèvre d'étanchéité	DIMENSIONEN Dimensions Dimensions (mm)	
	NR. No. N°	MATERIAL Material Matière	OBERFLÄCHE Surface Aspect		SERIE Series Série	MATERIAL Material Matière	OBERFLÄCHE Surface Aspect					d	h
			GLATT smooth lisse	MATT matt mat			GLATT smooth lisse	MATT matt mat					
3725	SAN	•			CITY	SAN/PP	•		•			69	51
					ELEGANCE	PP	•	•	•			66	52
					ELEGANCE-LIGHT PLUS	PP		•	•			66	54
					ELEGANCE PLUS	PP		•	•			66	53
					STANDARD	SAN	•		•			66	50
					STANDARD	PP	•		•			66	50
					STANDARD-R	PP/PP	•		•			66	54
					STEP	PS/PP		•	•			66	52
					TOP	PP/PP		•	•			66	53
					TOP	SAN/PP	•		•			66	52
					TOP-LIGHT	PP		•	•			66	50
					TOP-SPATEL	PP/PP		• ¹⁾	•			66	53
50	MIT EINSATZ with insert avec insert				(AUCH REDUZIER-EINSATZ 15 ODER 30 ml VORHANDEN we also stock reduction inserts in 15 ml and 30 ml réducteur également disponible en 15 ml ou 30 ml)								
3726	SAN/PP	•			CITY	SAN/PP	•		•			69	51
					ELEGANCE	PP	•	•	•			66	52
					ELEGANCE-LIGHT PLUS	PP		•	•			66	54
					ELEGANCE PLUS	PP		•	•			66	53
					STANDARD	SAN	•		•			66	50
					STANDARD	PP	•		•			66	50
					STANDARD-R	PP/PP	•		•			66	54
					STEP	PS/PP		•	•			66	52
					TOP	PP/PP		•	•			66	53
					TOP	SAN/PP	•		•			66	52
					TOP-LIGHT	PP		•	•			66	50
					TOP-SPATEL	PP/PP		• ¹⁾	•			66	53

¹⁾ Spatel glatt | scoop smooth | spatule lisse



GLASOPTIK-DOSEN | Glass-look jars | Pots paroi épaisse aspect verre

DIMENSIONEN | Dimensions | Dimensions

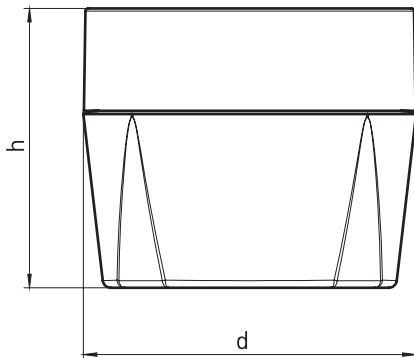

d = MAX. DURCHMESSER | Max. diameter | Diamètre max.
h = GESAMTHÖHE | Overall height | Hauteur totale

DECKELVARIANTEN | Optional lids | Variantes de couvercle

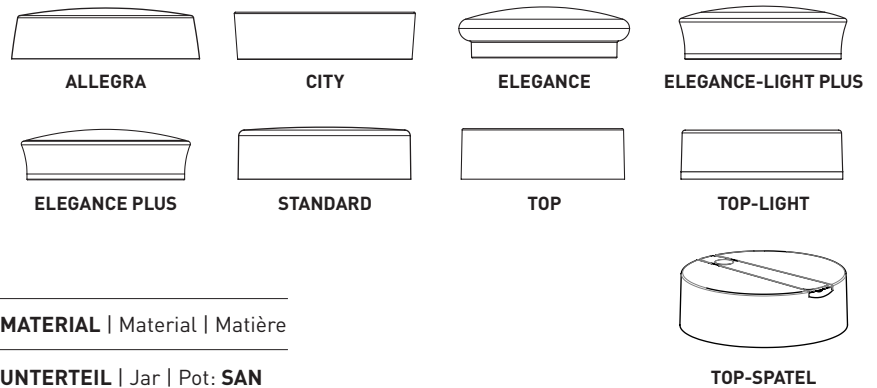

MATERIAL | Material | Matière

UNTERTEIL | Jar | Pot: **SAN**
EINSATZ | Insert | Insert: **PP**
SCHRAUBDECKEL | Lid | Couvercle à vis: **PP, SAN, PP/PP, SAN/PP**

INDIVIDUELLE DEKORATION

Einfärbung, Druck, Prägung, Lackierung und Metallisierung.

CUSTOMIZATION

Coloured material, printing, hot foil stamping, lacquering and metallization.

DÉCORATION PERSONNALISÉE

Coloration dans la masse, sérigraphie, marquage à chaud, laquage et métallisation.

TECHNISCHE DATEN | Technical details | Spécifications techniques

NENN-VOLUMEN Volume Volume ml	DOSENUNTERTEIL Jar Pot				SCHRAUBDECKEL Lid Couvercle à vis				EINLAGE Liner Joint	AUFPLAGE Disc Opercule	DICHTLIPPE Sealing rim Lèvre d'étanchéité	DIMENSIONEN Dimensions Dimensions (mm)	
	NR. No. N°	MATERIAL Material Matière	OBERFLÄCHE Surface Aspect		SERIE Series Série	MATERIAL Material Matière	OBERFLÄCHE Surface Aspect					d	h
			GLATT smooth lisse	MATT matt mat			GLATT smooth lisse	MATT matt mat					
3923	SAN	•			ALLEGRA	SAN/PP	•		•			45	41
					CITY	SAN/PP	•		•			45	39
					ELEGANCE	PP	•	•	•			45	39
					ELEGANCE-LIGHT PLUS	PP		•	•			45	39
					ELEGANCE PLUS	PP		•	•			45	39
					STANDARD	SAN	•		•			45	38
					STANDARD-R	PP/PP	•		•			45	41
					TOP	PP/PP		•	•			45	40
					TOP-LIGHT	PP		•	•			45	37
15	MIT EINSATZ with insert avec insert				[AUCH REDUZIER-EINSATZ 5 ml VORHANDEN we also stock reduction inserts in 5 ml réducteur également disponible en 5 ml]								
	3924	SAN/PP	•		ALLEGRA	SAN/PP	•		•			46	41
					CITY	SAN/PP	•		•			46	39
					ELEGANCE	PP	•	•	•			45	39
					ELEGANCE-LIGHT PLUS	PP		•	•			45	39
					ELEGANCE PLUS	PP		•	•			45	39
					STANDARD	SAN	•		•			45	38
					STANDARD-R	PP/PP	•		•			45	41
					TOP	PP/PP		•	•			45	40
					TOP-LIGHT	PP		•	•			45	37

GLASOPTIK-DOSEN | Glass-look jars | Pots paroi épaisse aspect verre

TECHNISCHE DATEN | Technical details | Spécifications techniques

NENNVOLUMEN Volume Volume ml	DOSENUNTERTEIL Jar Pot				SCHRAUBDECKEL Lid Couverture à vis				EINLAGE Liner Joint	AUFLAGE Disc Opercule	DICHTLIPPE Sealing rim Lèvre d'étanchéité	DIMENSIONEN Dimensions Dimensions (mm)	
	NR. No. N°	MATERIAL Material Matière	OBERFLÄCHE Surface Aspect		SERIE Series Série	MATERIAL Material Matière	OBERFLÄCHE Surface Aspect					d	h
			GLATT smooth lisse	MATT matt mat			GLATT smooth lisse	MATT matt mat					
3921	SAN	•			ELEGANCE	PP	•	•	•			62	54
					ELEGANCE-LIGHT PLUS	PP		•	•			62	53
					ELEGANCE PLUS	PP		•	•			64	54
					STANDARD	SAN	•		•			62	51
					STANDARD	PP	•		•			62	51
					STANDARD-R	PP/PP	•		•			62	55
					TOP	PP/PP		•	•			62	53
					TOP	SAN/PP	•		•			62	53
					TOP-LIGHT	PP		•	•			62	51
					TOP-SPATEL	PP/PP		• ¹⁾	•			62	53
50	MIT EINSATZ with insert avec insert				(AUCH REDUZIER-EINSATZ 15 ODER 30 ml VORHANDEN we also stock reduction inserts in 15 ml and 30 ml réducteur également disponible en 15 ml ou 30 ml)								
	3922	SAN/PP	•		ELEGANCE	PP	•	•	•			62	54
					ELEGANCE-LIGHT PLUS	PP		•	•			62	53
					ELEGANCE PLUS	PP		•	•			64	54
					STANDARD	SAN	•		•			62	51
					STANDARD	PP	•		•			62	51
					STANDARD-R	PP/PP	•		•			62	55
					TOP	PP/PP		•	•			62	53
					TOP	SAN/PP	•		•			62	53
					TOP-LIGHT	PP		•	•			62	51
TOP-SPATEL					PP/PP		• ¹⁾	•			62	53	

¹⁾ Spatel glatt | scoop smooth | spatule lisse



GLASOPTIK-DOSEN | Glass-look jars | Pots paroi épaisse aspect verre

DIMENSIONEN | Dimensions | Dimensions

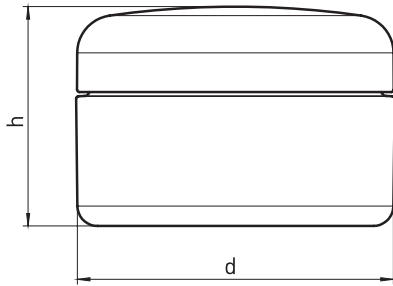

d = MAX. DURCHMESSER | Max. diameter | Diamètre max.
h = GESAMTHÖHE | Overall height | Hauteur totale

DECKELVARIANTEN | Optional lids | Variantes de couvercle

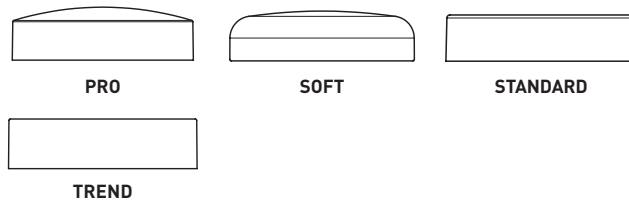

MATERIAL | Material | Matière

UNTERTEIL | Jar | Pot: **SAN**
EINSATZ | Insert | Insert: **PP**
SCHRAUBDECKEL | Lid | Couvercle à vis: **PP, SAN**

INDIVIDUELLE DEKORATION

Einfärbung, Druck, Prägung, Lackierung und Metallisierung.

CUSTOMIZATION

Coloured material, printing, hot foil stamping, lacquering and metallization.

DÉCORATION PERSONNALISÉE

Coloration dans la masse, sérigraphie, marquage à chaud, laquage et métallisation.

TECHNISCHE DATEN | Technical details | Spécifications techniques

NENNVOLUMEN Volume Volume ml	DOSENUNTERTEIL Jar Pot				SCHRAUBDECKEL Lid Couvercle à vis				EINLAGE Liner Joint	AUFPLAGE Disc Opercule	DICHTLIPPE Sealing rim Lèvre d'étanchéité	DIMENSIONEN Dimensions Dimensions (mm)						
	NR. No. N°	MATERIAL Material Matière	OBERFLÄCHE Surface Aspect		SERIE Series Série	MATERIAL Material Matière	OBERFLÄCHE Surface Aspect					d	h					
			GLATT smooth lisse	MATT matt mat			GLATT smooth lisse	MATT matt mat										
5	3327	SAN	•		SOFT	SAN	•		•		•	33	26					
					STANDARD	SAN	•		•		•	33	25					
30	3828	SAN	•		PRO	SAN	•		•			59	37					
					PRO	PP	•		•		•	59	36					
					SOFT	SAN	•	•	•		•	59	37					
					SOFT	PP	•	•	•		•	59	38					
					STANDARD	SAN	•		•		•	59	33					
					STANDARD	PP	•	•	•		•	59	33					
					MIT EINSATZ with insert avec insert													
30	3829	SAN/PP	•		PRO	SAN	•		•			59	38					
					PRO	PP	•		•		•	59	37					
					SOFT	SAN	•	•	•		•	59	38					
					SOFT	PP	•	•	•		•	59	39					
					STANDARD	SAN	•		•		•	59	34					
					STANDARD	PP	•	•	•		•	59	34					
50	3830	SAN	•		SOFT	SAN	•		•			63	44					
					MIT EINSATZ with insert avec insert													
					3831	SAN/PP	•		PRO	PP	•		•			63	47	
									SOFT	SAN	•		•		•	63	45	
									SOFT	PP	•	•	•		•	63	45	
TREND	PP	•	•	•						•	63	42						

GLASOPTIK-DOSEN | Glass-look jars | Pots paroi épaisse aspect verre

DIMENSIONEN | Dimensions | Dimensions

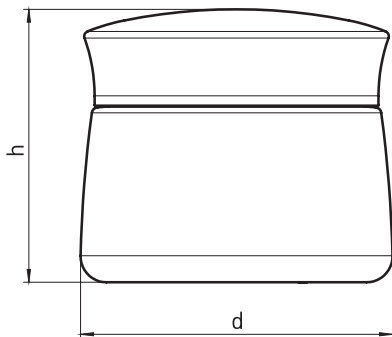

d = MAX. DURCHMESSER | Max. diameter | Diamètre max.
h = GESAMTHÖHE | Overall height | Hauteur totale

DECKELVARIANTEN | Optional lids | Variantes de couvercle

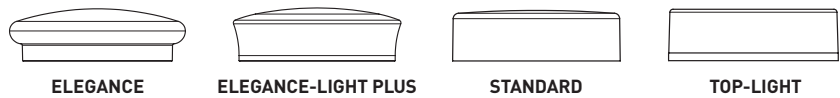

MATERIAL | Material | Matière

UNTERTEIL | Jar | Pot: **SAN**
EINSATZ | Insert | Insert: **PP**
SCHRAUBDECKEL | Lid | Couvercle à vis: **PP, SAN**

INDIVIDUELLE DEKORATION

Einfärbung, Druck, Prägung, Lackierung und Metallisierung.

CUSTOMIZATION

Coloured material, printing, hot foil stamping, lacquering and metallization.

DÉCORATION PERSONNALISÉE

Coloration dans la masse, sérigraphie, marquage à chaud, laquage et métallisation.

TECHNISCHE DATEN | Technical details | Spécifications techniques

NENN-VOLUMEN Volume Volume ml	DOSENUNTERTEIL Jar Pot				SCHRAUBDECKEL Lid Couvercle à vis							DIMENSIONEN Dimensions Dimensions (mm)	
	NR. No. N°	MATERIAL Material Matière	OBERFLÄCHE Surface Aspect		SERIE Series Série	MATERIAL Material Matière	OBERFLÄCHE Surface Aspect		EINLAGE Liner Joint	AUFPLAGE Disc Opercule	DICHTLIPPE Sealing rim Lèvre d'étanchéité	d	h
			GLATT smooth lisse	MATT mat mat			GLATT smooth lisse	MATT mat mat					
5	3776	SAN	•		ELEGANCE	PP	•	•	•			43	38
					ELEGANCE-LIGHT PLUS	PP		•	•			43	38
					STANDARD	SAN	•		•			43	37
15	MIT EINSATZ with insert avec insert				[AUCH REDUZIER-EINSATZ 5 ml VORHANDEN we also stock reduction inserts in 5 ml réducteur également disponible en 5 ml]								
	3782	SAN/PP	•		ELEGANCE	PP	•	•	•			43	39
					ELEGANCE-LIGHT PLUS	PP		•	•			43	39
					STANDARD	SAN	•		•			43	38
STANDARD					PP	•		•			61	51	
30	3775	SAN	•		ELEGANCE	PP	•	•	•			62	53
					ELEGANCE-LIGHT PLUS	PP		•	•			61	54
					STANDARD	SAN	•		•			61	51
					STANDARD	PP	•		•			61	51
					TOP-LIGHT	PP		•	•			61	52
50	MIT EINSATZ with insert avec insert				[AUCH REDUZIER-EINSATZ 15 ODER 30 ml VORHANDEN we also stock reduction inserts in 15 ml and 30 ml réducteur également disponible en 15 ml ou 30 ml]								
	3781	SAN/PP	•		ELEGANCE	PP	•	•	•			62	54
					ELEGANCE-LIGHT PLUS	PP		•	•			61	55
					STANDARD	SAN	•		•			61	52
					STANDARD	PP	•		•			61	52
					TOP-LIGHT	PP		•	•			61	53
TOP-LIGHT					PP		•	•			61	52	
100	3849	SAN	•		STANDARD	PP	•		•			87	78
					ELEGANCE	PP		•	•			90	83
					STANDARD	PP	•		•			87	79
200	MIT EINSATZ with insert avec insert												
	3850	SAN/PP	•		STANDARD	PP	•		•			87	79
ELEGANCE					PP		•	•			90	84	

GLASOPTIK-DOSEN | Glass-look jars | Pots paroi épaisse aspect verre

DIMENSIONEN | Dimensions | Dimensions

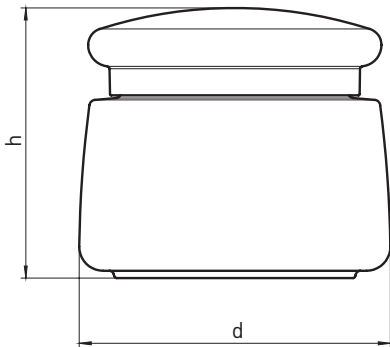

d = MAX. DURCHMESSER | Max. diameter | Diamètre max.
h = GESAMTHÖHE | Overall height | Hauteur totale

DECKELVARIANTEN | Optional lids | Variantes de couvercle

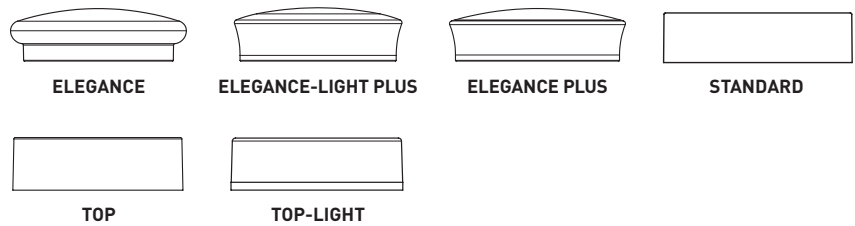

MATERIAL | Material | Matière

UNTERTEIL | Jar | Pot: **SAN**
EINSATZ | Insert | Insert: **PP**
SCHRAUBDECKEL | Lid | Couvercle à vis: **PP, SAN, SAN/PP**

INDIVIDUELLE DEKORATION

Einfärbung, Druck, Prägung, Lackierung und Metallisierung.

CUSTOMIZATION

Coloured material, printing, hot foil stamping, lacquering and metallization.

DÉCORATION PERSONNALISÉE

Coloration dans la masse, sérigraphie, marquage à chaud, laquage et métallisation.

TECHNISCHE DATEN | Technical details | Spécifications techniques

NENN-VOLUMEN Volume Volume ml	DOSENUNTERTEIL Jar Pot				SCHRAUBDECKEL Lid Couvercle à vis				EINLAGE Liner Joint	AUFPLAGE Disc Opercule	DICHTLIPPE Sealing rim Lèvre d'étanchéité	DIMENSIONEN Dimensions Dimensions (mm)	
	NR. No. N°	MATERIAL Material Matière	OBERFLÄCHE Surface Aspect		SERIE Series Série	MATERIAL Material Matière	OBERFLÄCHE Surface Aspect					d	h
			GLATT smooth lisse	MATT matt mat			GLATT smooth lisse	MATT matt mat					
3600	SAN	•		ELEGANCE	PP	•	•	•			46	40	
				ELEGANCE-LIGHT PLUS	PP		•	•		46	40		
				ELEGANCE PLUS	PP		•	•		46	40		
				STANDARD	SAN	•		•		46	38		
				TOP-LIGHT	PP		•	•		46	38		
15	MIT EINSATZ with insert avec insert				[AUCH REDUZIER-EINSATZ 5 ml VORHANDEN we also stock reduction inserts in 5 ml réducteur également disponible en 5 ml]								
	3623	SAN/PP	•		ELEGANCE	PP	•	•	•			46	41
					ELEGANCE-LIGHT PLUS	PP		•	•		46	41	
					ELEGANCE PLUS	PP		•	•		46	41	
					STANDARD	SAN	•		•		46	39	
					TOP-LIGHT	PP		•	•		46	39	
3847	SAN	•		ELEGANCE	PP	•	•	•			56	49	
				ELEGANCE PLUS	PP		•	•		56	49		
				STANDARD	SAN	•		•		56	46		
				TOP	SAN/PP	•		•		56	49		
30	MIT EINSATZ with insert avec insert				[AUCH REDUZIER-EINSATZ 15 ml VORHANDEN we also stock reduction inserts in 15 ml réducteur également disponible en 15 ml]								
	3848	SAN/PP	•		ELEGANCE	PP	•	•	•			56	50
					ELEGANCE PLUS	PP		•	•		56	50	
					STANDARD	SAN	•		•		56	47	
TOP	SAN/PP	•		•		56	50						

GLASOPTIK-DOSEN | Glass-look jars | Pots paroi épaisse aspect verre

TECHNISCHE DATEN | Technical details | Spécifications techniques

NENNVOLUMEN Volume Volume ml	DOSENUNTERTEIL Jar Pot				SCHRAUBDECKEL Lid Couverture à vis				EINLAGE Liner Joint	AUFLAGE Disc Opercule	DICHTLIPPE Sealing rim Lèvre d'étanchéité	DIMENSIONEN Dimensions Dimensions (mm)	
	NR. No. N°	MATERIAL Material Matière	OBERFLÄCHE Surface Aspect		SERIE Series Série	MATERIAL Material Matière	OBERFLÄCHE Surface Aspect					d	h
			GLATT smooth lisse	MATT matt mat			GLATT smooth lisse	MATT matt mat					
50	3681	SAN	•		ELEGANCE	PP	•	•	•			66	57
					ELEGANCE-LIGHT PLUS	PP		•	•		66	56	
					ELEGANCE PLUS	PP		•	•		66	58	
					STANDARD	SAN	•		•		66	55	
					STANDARD	PP	•		•		66	55	
					TOP-LIGHT	PP		•	•		66	55	
MIT EINSATZ with insert avec insert (AUCH REDUZIER-EINSATZ 15 ODER 30 ml VORHANDEN we also stock reduction inserts in 15 ml and 30 ml réducteur également disponible en 15 ml ou 30 ml)													
50	3683	SAN/PP	•		ELEGANCE	PP	•	•	•			66	58
					ELEGANCE-LIGHT PLUS	PP		•	•		66	57	
					ELEGANCE PLUS	PP		•	•		66	59	
					STANDARD	SAN	•		•		66	56	
					STANDARD	PP	•		•		66	56	
					TOP-LIGHT	PP		•	•		66	56	
200	3735	SAN	•		STANDARD	PP	•		•			95	78
					ELEGANCE	PP		•	•		95	82	
	MIT EINSATZ with insert avec insert												
200	3736	SAN/PP	•		STANDARD	PP	•		•			95	79
					ELEGANCE	PP		•	•		95	83	

GLASOPTIK-DOSEN | Glass-look jars | Pots paroi épaisse aspect verre

DIMENSIONEN | Dimensions | Dimensions

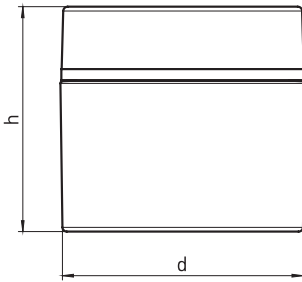

d = MAX. DURCHMESSER | Max. diameter | Diamètre max.
h = GESAMTHÖHE | Overall height | Hauteur totale

DECKELVARIANTEN | Optional lids | Variantes de couvercle

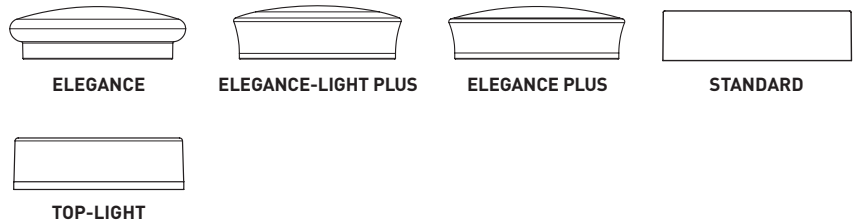

MATERIAL | Material | Matière

UNTERTEIL | Jar | Pot: **SAN**
EINSATZ | Insert | Insert: **PP**
SCHRAUBDECKEL | Lid | Couvercle à vis: **PP, SAN**

INDIVIDUELLE DEKORATION

Einfärbung, Druck, Prägung, Lackierung und Metallisierung.

CUSTOMIZATION

Coloured material, printing, hot foil stamping, lacquering and metallization.

DÉCORATION PERSONNALISÉE

Coloration dans la masse, sérigraphie, marquage à chaud, laquage et métallisation.

TECHNISCHE DATEN | Technical details | Spécifications techniques

NENN-VOLUMEN Volume Volume ml	DOSENUNTERTEIL Jar Pot				SCHRAUBDECKEL Lid Couvercle à vis				EINLAGE Liner Joint	AUFPLAGE Disc Opercule	DICHTLIPPE Sealing rim Lèvre d'étanchéité	DIMENSIONEN Dimensions Dimensions (mm)	
	NR. No. N°	MATERIAL Material Matière	OBERFLÄCHE Surface Aspect		SERIE Series Série	MATERIAL Material Matière	OBERFLÄCHE Surface Aspect					d	h
			GLATT smooth lisse	MATT matt mat			GLATT smooth lisse	MATT matt mat					
3858	SAN	•			ELEGANCE	PP	•	•	•			43	38
					ELEGANCE-LIGHT PLUS	PP		•	•			42	39
					ELEGANCE PLUS	PP		•	•			45	38
					STANDARD	SAN	•		•			41	37
					TOP-LIGHT	PP		•	•			41	37
15	MIT EINSATZ with insert avec insert				[AUCH REDUZIER-EINSATZ 5 ml VORHANDEN we also stock reduction inserts in 5 ml réducteur également disponible en 5 ml]								
	3859	SAN/PP	•		ELEGANCE	PP	•	•	•			43	39
					ELEGANCE-LIGHT PLUS	PP		•	•			42	40
					ELEGANCE PLUS	PP		•	•			45	39
					STANDARD	SAN	•		•			41	38
					TOP-LIGHT	PP		•	•			41	38
3860	SAN	•			ELEGANCE	PP	•	•	•			62	54
					ELEGANCE-LIGHT PLUS	PP		•	•			60	54
					STANDARD	PP	•		•			56	52
					STANDARD	SAN	•		•			56	52
					TOP-LIGHT	PP		•	•			56	53
50	MIT EINSATZ with insert avec insert				[AUCH REDUZIER-EINSATZ 15 ODER 30 ml VORHANDEN we also stock reduction inserts in 15 ml and 30 ml réducteur également disponible en 15 ml ou 30 ml]								
	3861	SAN/PP	•		ELEGANCE	PP	•	•	•			62	55
					ELEGANCE-LIGHT PLUS	PP		•	•			60	55
					STANDARD	PP	•		•			56	53
					STANDARD	SAN	•		•			56	53
					TOP-LIGHT	PP		•	•			56	54

GLASOPTIK-DOSEN | Glass-look jars | Pots paroi épaisse aspect verre

DIMENSIONEN | Dimensions | Dimensions

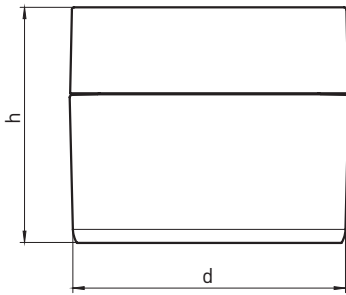

d = MAX. DURCHMESSER | Max. diameter | Diamètre max.
h = GESAMTHÖHE | Overall height | Hauteur totale

DECKELVARIANTEN | Optional lids | Variantes de couvercle

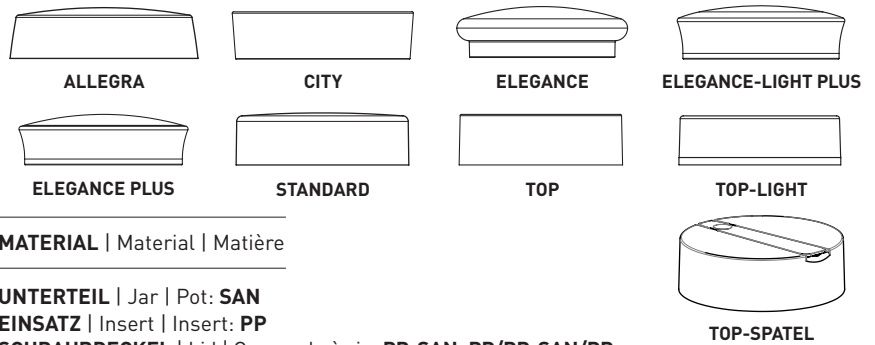

MATERIAL | Material | Matière

UNTERTEIL | Jar | Pot: **SAN**
EINSATZ | Insert | Insert: **PP**
SCHRAUBDECKEL | Lid | Couvercle à vis: **PP, SAN, PP/PP, SAN/PP**

INDIVIDUELLE DEKORATION

Einfärbung, Druck, Prägung, Lackierung und Metallisierung.

CUSTOMIZATION

Coloured material, printing, hot foil stamping, lacquering and metallization.

DÉCORATION PERSONNALISÉE

Coloration dans la masse, sérigraphie, marquage à chaud, laquage et métallisation.

TECHNISCHE DATEN | Technical details | Spécifications techniques

NENNVOLUMEN Volume Volume ml	DOSENUNTERTEIL Jar Pot				SCHRAUBDECKEL Lid Couvercle à vis				EINLAGE Liner Joint	AUFLAGE Disc Opercule	DICHTLIPPE Sealing rim Lèvre d'étanchéité	DIMENSIONEN Dimensions Dimensions (mm)	
	NR. No. N°	MATERIAL Material Matière	OBERFLÄCHE Surface Aspect		SERIE Series Série	MATERIAL Material Matière	OBERFLÄCHE Surface Aspect					d	h
			GLATT smooth lisse	MATT matt mat			GLATT smooth lisse	MATT matt mat					
3766	SAN	•			ALLEGRA	SAN/PP	•		•			45	39
					CITY	SAN/PP	•		•			45	39
					ELEGANCE	PP	•	•	•			45	39
					ELEGANCE-LIGHT PLUS	PP		•	•			45	39
					ELEGANCE PLUS	PP		•	•			45	39
					STANDARD	SAN	•		•			45	39
					STANDARD-R	PP/PP	•		•			45	39
					TOP	PP/PP		•	•			45	39
					TOP	SAN/PP	•		•			45	39
					TOP-LIGHT	PP		•	•		45	39	
15	MIT EINSATZ with insert avec insert				[AUCH REDUZIER-EINSATZ 5 ml VORHANDEN we also stock reduction inserts in 5 ml réducteur également disponible en 5 ml]								
	3767	SAN/PP	•		ALLEGRA	SAN/PP	•		•			45	40
					CITY	SAN/PP	•		•			45	40
					ELEGANCE	PP	•	•	•			45	40
					ELEGANCE-LIGHT PLUS	PP		•	•			45	40
					ELEGANCE PLUS	PP		•	•			45	40
					STANDARD	SAN	•		•			45	40
					STANDARD-R	PP/PP	•		•			45	40
					TOP	PP/PP		•	•			45	40
					TOP	SAN/PP	•		•			45	40
									TOP-LIGHT	PP		•	•

GLASOPTIK-DOSEN | Glass-look jars | Pots paroi épaisse aspect verre

TECHNISCHE DATEN | Technical details | Spécifications techniques

NENNVOLUMEN Volume Volume ml	DOSENUNTERTEIL Jar Pot				SCHRAUBDECKEL Lid Couverture à vis				EINLAGE Liner Joint	AUFLAGE Disc Opercule	DICHTLIPPE Sealing rim Lèvre d'étanchéité	DIMENSIONEN Dimensions Dimensions (mm)	
	NR. No. N°	MATERIAL Material Matière	OBERFLÄCHE Surface Aspect		SERIE Series Série	MATERIAL Material Matière	OBERFLÄCHE Surface Aspect					d	h
			GLATT smooth lisse	MATT matt mat			GLATT smooth lisse	MATT matt mat					
30	3838	SAN	•		ELEGANCE	PP	•	•	•			53	46
					ELEGANCE PLUS	PP		•	•		55	46	
					STANDARD	SAN	•		•		53	43	
					TOP	SAN/PP	•		•		53	46	
MIT EINSATZ with insert avec insert					[AUCH REDUZIER-EINSATZ 15 ml VORHANDEN we also stock reduction inserts in 15 ml réducteur également disponible en 15 ml]								
30	3839	SAN/PP	•		ELEGANCE	PP	•	•	•			53	47
					ELEGANCE PLUS	PP		•	•		55	47	
					STANDARD	SAN	•		•		53	44	
					TOP	SAN/PP	•		•		53	47	
50	3729	SAN	•		ELEGANCE	PP	•	•	•			62	52
					ELEGANCE-LIGHT PLUS	PP		•	•		62	53	
					ELEGANCE PLUS	PP		•	•		64	53	
					STANDARD	SAN	•		•		62	50	
					STANDARD	PP	•		•		62	50	
					STANDARD-R	PP/PP	•		•		62	54	
					TOP	PP/PP		•	•		62	53	
					TOP	SAN/PP	•		•		62	53	
					TOP-LIGHT	PP		•	•		62	50	
					TOP-SPATEL	PP/PP		• ¹¹	•		62	53	
MIT EINSATZ with insert avec insert					[AUCH REDUZIER-EINSATZ 15 ml oder 30 ml VORHANDEN we also stock reduction inserts in 15 ml or 30 ml réducteur également disponible en 15 ml ou 30 ml]								
50	3730	SAN/PP	•		ELEGANCE	PP	•	•	•			62	52
					ELEGANCE-LIGHT PLUS	PP		•	•		62	53	
					ELEGANCE PLUS	PP		•	•		64	53	
					STANDARD	SAN	•		•		62	50	
					STANDARD	PP	•		•		62	50	
					STANDARD-R	PP/PP	•		•		62	54	
					TOP	PP/PP		•	•		62	53	
					TOP	SAN/PP	•		•		62	53	
					TOP-LIGHT	PP		•	•		62	50	
					TOP-SPATEL	PP/PP		• ¹¹	•		62	53	

¹¹ Spatel glatt | scoop smooth | spatule lisse

GLASOPTIK-DOSEN | Glass-look jars | Pots paroi épaisse aspect verre

DIMENSIONEN | Dimensions | Dimensions

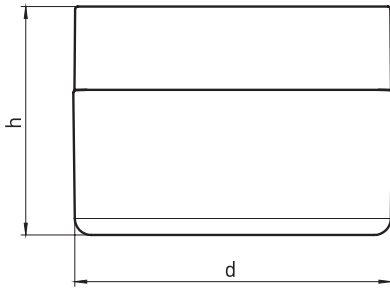

d = MAX. DURCHMESSER | Max. diameter | Diamètre max.
h = GESAMTHÖHE | Overall height | Hauteur totale

DECKELVARIANTEN | Optional lids | Variantes de couvercle

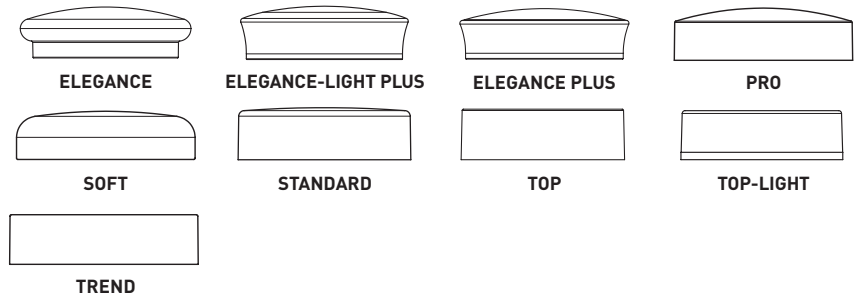

MATERIAL | Material | Matière

UNTERTEIL | Jar | Pot: **SAN**
EINSATZ | Insert | Insert: **PP**
SCHRAUBDECKEL | Lid | Couvercle à vis: **PP, SAN, SAN/PP, PP/PP**

INDIVIDUELLE DEKORATION

Einfärbung, Druck, Prägung, Lackierung und Metallisierung.

CUSTOMIZATION

Coloured material, printing, hot foil stamping, lacquering and metallization.

DÉCORATION PERSONNALISÉE

Coloration dans la masse, sérigraphie, marquage à chaud, laquage et métallisation.

TECHNISCHE DATEN | Technical details | Spécifications techniques

NENNVOLUMEN Volume Volume ml	DOSENUNTERTEIL Jar Pot				SCHRAUBDECKEL Lid Couvercle à vis				EINLAGE Liner Joint	AUFPLAGE Disc Opercule	DICHTLIPPE Sealing rim Lèvre d'étanchéité	DIMENSIONEN Dimensions Dimensions (mm)	
	NR. No. N°	MATERIAL Material Matière	OBERFLÄCHE Surface Aspect		SERIE Series Série	MATERIAL Material Matière	OBERFLÄCHE Surface Aspect					d	h
			GLATT smooth lisse	MATT matt mat			GLATT smooth lisse	MATT matt mat					
5	3327	SAN	•		SOFT	SAN	•		•		•	33	26
					STANDARD	SAN	•		•		•	33	25
30	3927	SAN	•		ELEGANCE	PP	•	•	•			62	40
					ELEGANCE-LIGHT PLUS	PP		•	•			62	41
					ELEGANCE PLUS	PP		•	•			64	41
					STANDARD	SAN	•		•			62	38
					STANDARD	PP	•		•			62	38
					STANDARD-R	PP/PP	•		•			62	42
					TOP	PP/PP		•	•			62	41
					TOP	SAN/PP	•		•			62	41
					TOP-LIGHT	PP		•	•			62	38
[AUCH REDUZIER-EINSATZ 15 ml VORHANDEN we also stock reduction inserts in 15 ml réducteur également disponible en 15 ml]													
50	3822	SAN	•		PRO	PP	•		•			68	50
					SOFT	SAN	•		•		68	49	
					SOFT	PP	•	•	•		68	47	
					TREND	SAN/PP	•	•	•		68	50	
					MIT EINSATZ with insert avec insert								
50	3823	SAN/PP	•		PRO	PP	•		•			68	51
					SOFT	SAN	•		•		68	50	
					SOFT	PP	•	•	•		68	48	
					TREND	SAN/PP	•	•	•		68	51	

GLASOPTIK-DOSEN | Glass-look jars | Pots paroi épaisse aspect verre

TECHNISCHE DATEN | Technical details | Spécifications techniques

NENNVOLUMEN Volume Volume ml	DOSENUNTERTEIL Jar Pot				SCHRAUBDECKEL Lid Couvercle à vis				EINLAGE Liner Joint	AUFLAGE Disc Opercule	DICHTLIPPE Sealing rim Lèvre d'étanchéité	DIMENSIONEN Dimensions Dimensions (mm)	
	NR. No. N°	MATERIAL Material Matière	OBERFLÄCHE Surface Aspect		SERIE Series Série	MATERIAL Material Matière	OBERFLÄCHE Surface Aspect					d	h
			GLATT smooth lisse	MATT matt mat			GLATT smooth lisse	MATT matt mat					
100	3948	SAN	•		TREND	SAN/PP	•		•		79	57	
	MIT EINSATZ with insert avec insert												
	3949	SAN/PP	•		TREND	SAN/PP	•		•		79	57	
200	3834	SAN	•		TREND	SAN/PP	•		•		95	68	
	MIT EINSATZ with insert avec insert												
	3835	SAN/PP	•		TREND	SAN/PP	•		•		95	69	



hopf

www.hopf.de

Interesse? Fragen? Wir sind gerne für Sie da!

Hopf Packaging GmbH

Wemdinger Str. 13 | D-86720 Nördlingen
(Besucher-Anfahrt über Reutheweg)

Telefon +49 9081-806-0

Telefax +49 9081-806-200 (Vertrieb)

E-Mail info@hopf.de

Web www.hopf.de

QR-Code scannen &
Website besuchen!

